



INJECTION MOLDED CASES (EXCLUDES VAULT BY PELICAN) - LIMITED LIFETIME WARRANTY

Pelican Products, Inc. ("Pelican") guarantees its injection molded products for a lifetime against breakage or defects in workmanship. Pelican™ injection molded cases are guaranteed to be watertight to a depth of 3.3 feet (1 meter) for 30 minutes if properly closed with undamaged o-ring in place unless otherwise stated. To the extent permitted by law, Pelican's liability is limited to the case and not its contents or foam. Pelican will either repair or replace any broken or defective product, at our sole option. All warranty claims of any nature are barred if the product has been altered, damaged or in any way physically changed, or subjected to abuse, misuse, negligence or accident.

In Australia: www.pelican.com/warranty/australia

Lifetime Warranty does not cover Vault by Pelican or Roto Molded cases.

For complete warranty details, see www.pelican.com/support/warranty

U.S.A.

CALIFORNIA
23215 Early Avenue
Torrance, CA 90505
Tel: 310.326.4700
800.473.5422
Fax: 310.326.3311
www.pelican.com

MASSACHUSETTS
147 North Main Street
South Deerfield, MA 01373
Tel: 800.542.7344
Fax: 413.665.8330
www.pelican.com

INTERNATIONAL

EUROPE, MIDDLE EAST AND AFRICA
Peli Products, S.L.U.
c/ Provença, 388, Planta 7
Barcelona, Spain, 08025
Tel: +34.934.674.999
Fax: +34.934.877.393
www.peli.com

JAPAN
Pelican Products K.K.
Nisso 22 Bldg 9F
1-11-10 Azabu Dai
Minato ward Tokyo
Japan 106-0041
Tel: +81.33.585.9100
Fax: +81.33.585.9109
www.pelican.com/jp

CANADA
Pelican Products ULC
10221-184th Street
Edmonton, Alberta
T5S 2J4, Canada
Tel: +780.481.6076
Fax: +780.481.9586
www.pelican.ca

AUSTRALIA
Pelican Products Pty Ltd
West Wing, Platinum Building, Suite 2.33
4 Ilya Av
Erina NSW 2250
Tel: +612.4367.7022
Fax: +612.4367.7066
www.pelicanaustralia.com

CHINA
Pelican Products China Representative Office
Pine City Building, Room 1026
777 Zhaojiabang Road
Shanghai, China 200032
Tel: +86.21.64189685
Fax: +86.21.64189679
www.pelican.com/cn

KOREA
Pelican Products Korea Ltd
#909 Hyundai 41 Tower, #2616
917-9, Mok-dong, Yangchon-gu, Seoul, Korea 158-050
Tel: +82.2.6092.4700
Fax: +82.2.6739.4700
www.pelican.com/ko

INDIA and SOUTH ASIA (Bangladesh, Bhutan, Maldives, Nepal, Sri Lanka)
Pelican Products and Services India Pvt. Ltd,
GF 9&10, Augusta Point
Sector-53, Golf Course Road
Haryana, Gurgaon 122002, India
Tel: +91.124.4377227
Fax: +91.124.4049227
www.pelican.com

SE ASIA and rest of ASIA (Hong Kong, Macau, Taiwan, Pakistan)
No.777, Pine City Building ZhaoJiaBang Road
#10-26 XuHui District
Shanghai, China 200032
Phone: +86.21.64189685
Fax: +86.21.64189679
www.pelican.com

LATIN AMERICA
23215 Early Avenue
Torrance, California 90505 USA
Tel: +1.310.326.4700 x 1462
Fax: +1.310.325.5740
www.pelican.com



DISTRIBUTED BY:



©2019 Pelican Products, Inc. All trademarks are registered and/or unregistered trademarks of Pelican Products, Inc., its subsidiaries and/or affiliates. VELCRO® is a registered trademark of Velcro Industries B.V. Mylar® is a registered trademark of E.I. du Pont de Nemours and Company. Ultrabook™ is a trademark of Intel. MITUTOYO® is a registered trademark of Bukkyo Dendo Kyokai, a Japanese company.

Part No. 0030-000-300 JN/19



WATERTIGHT PROTECTOR CASES
CASE CATALOG
JUNE 2019
SINCE 1976



PELICAN
CASE CATALOG

JUNE 2019



Dear Pelican Customer,

Our first Pelican™ Protector Case™ launched in 1978. Now, over 40 years later, Pelican Products, Inc. continues to lead the industry in the design and manufacture of the toughest and highest quality cases on the market.

Since joining Pelican, I have watched our teams take an already successful brand of go-to protective equipment cases and continuously innovate and expand upon them. In 2016 we introduced the Pelican™ Air case line, engineered to maintain the same standard of durability, but reduce the weight of each case by up to 40 percent. This relentless quest to offer Pelican users more versatility than ever before has been an unprecedented success for the company and we continue to release new sizes, colors and uses for the Pelican™ Air case line.

In response to customer feedback and demand, we made an addition to the line in 2019, the Pelican™ Air 1745 Case. This case is the longest Pelican™ Air case to be introduced, as well as the deepest of all Pelican long cases, boasting more than 5,900 square inches of interior space. The Pelican™ Air 1745 Case form factor was developed to protect all manners of equipment, including survey equipment, firearms, archery gear, and musical instruments, in the harshest environments.

Also added to the groundbreaking line is the Pelican™ Air 1465EMS Case, developed with first responders in mind. When every second counts, these professionals need a tough and lighter weight case with features such as a new three-tier, customizable, pull out tray system, Press and Pull latches that can survive great pressure, and a lid equipped with a polymer O-ring for a dust and water-resistant (IP66) seal.

Pelican continues to work tirelessly to innovate and improve our products and services. We would not be the global brand that we are today without the consistent support of our loyal customers. Thank you to all those who depend on Pelican for your equipment protection needs every day.

Lyndon Faulkner
Chief Executive Officer

MARKETS SERVED //

**FIRE
MILITARY
INDUSTRIAL
LAW ENFORCEMENT
OUTDOOR
CONSUMER
DIVE**



TABLE OF CONTENTS

- PELICAN™ AIR CASE SERIES 1
- NEW** ■ PELICAN™ PUC SERIES 5
- PELICAN™ PROTECTOR CASE™ SERIES 7
 - Memory Card & Micro Cases 9
 - Small Cases 11
 - Digital Survival Cases 12
 - Medium Cases 15
 - Large Cases 17
 - Long Cases 21
- PELICAN™ STORM CASE™ SERIES 23
 - Small Cases 25
 - Medium Cases 26
 - Large Cases 28
- CASE SPECIFICATIONS 31
- CASE INTERIOR SIZE COMPARISON 33
- SERVICES & ACCESSORIES 35

www.pelican.com



PELICAN™ AIR CASE SERIES

OUR LIGHTEST CASE WITH THE PROTECTION YOU NEED

At up to 40% lighter than other polymer cases, Pelican™ Air cases lighten the loads of the dedicated pros around the world who have set out to change the game.



PELICAN™ AIR CASE COLORS AVAILABLE

*Not available in all case sizes.



BLACK



SILVER



YELLOW



ORANGE



THE SCIENCE OF LIGHTNESS

Molded from the next generation of Pelican's lightweight HPX™ resin, a proprietary formula that rebounds without breaking, the honeycomb structural elements are actually stronger than solid polymer material.

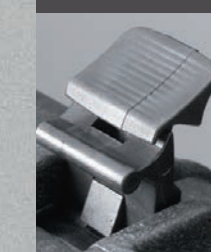

DOUBLE-THROW LATCHES

Double-Throw latches are smarter and easier to open: it's the classic 'C' clamp design with a secondary movement that works like a pry bar to start the release and offers plenty of leverage to open with a light pull.



WATERTIGHT

The secret is the tongue-and-groove fit with a polymer o-ring acting as a waterproof seal. Also, our Automatic Pressure Equalization Valve releases built-up air pressure while keeping water molecules out, resulting in a watertight case that is easy to open.



EASY RIDING

Stainless steel ball bearing wheels (on select cases) last longer and ride smoother. The nylon hub adjacent to the stainless steel resists heat resulting in less wear and tear on the polyurethane tire.



TESTED

The Pelican™ Protector Case™ design is the result of multiple generations of refinement. This evolution is proven through submergence and other lab tests.



1465

NEW

INTERNAL DIMS:
18.62" x 9.99" x 10.93"
(47.3 x 25.4 x 27.8 cm)

EXTERNAL DIMS:
20.83" x 12.62" x 12.75"
(52.9 x 32.1 x 32.4 cm)

■
Cat. No. 1465 **WF**
Cat. No. 1465NF **NF**



1465EMS

NEW

INTERNAL DIMS:
18.62" x 9.99" x 10.93"
(47.3 x 25.4 x 27.8 cm)

EXTERNAL DIMS:
20.83" x 12.62" x 12.75"
(52.9 x 32.1 x 32.4 cm)

■
Cat. No. 1465EMS
Case with custom configured
lid organizer and trays for EMS
professionals.



1485

INTERNAL DIMS:
17.75" x 10.18" x 6.15"
(45.1 x 25.9 x 15.6 cm)

EXTERNAL DIMS:
19.17" x 12.80" x 6.89"
(48.7 x 32.5 x 17.5 cm)

■ ■ ■ ■ ■
Cat. No. 1485 **WF**
Cat. No. 1485NF **NF**
Cat. No. 1485WD **WD**
Cat. No. 1485TP **TP**



1507

INTERNAL DIMS:
15.15" x 11.38" x 8.52"
(38.5 x 28.9 x 21.6 cm)

EXTERNAL DIMS:
16.87" x 14.10" x 9.27"
(42.8 x 35.8 x 23.5 cm)

■ ■ ■ ■ ■
Cat. No. 1507 **WF**
Cat. No. 1507NF **NF**
Cat. No. 1507WD **WD**
Cat. No. 1507TP **TP**



1525

INTERNAL DIMS:
20.50" x 11.31" x 6.75"
(52.1 x 28.7 x 17.1 cm)

EXTERNAL DIMS:
21.96" x 13.97" x 7.49"
(55.8 x 35.5 x 19 cm)

■ ■ ■ ■ ■
Cat. No. 1525 **WF**
Cat. No. 1525NF **NF**
Cat. No. 1525WD **WD**
Cat. No. 1525TP **TP**



1535 WHEELED CARRY-ON



INTERNAL DIMS:
20.39" x 11.20" x 7.21"
(51.8 x 28.4 x 18.3 cm)

EXTERNAL DIMS:
21.96" x 13.97" x 8.98"
(55.8 x 35.5 x 22.8 cm)

■ ■ ■ ■ ■
Cat. No. 1535 **WF**
Cat. No. 1535NF **NF**
Cat. No. 1535WD **WD**
Cat. No. 1535TP **TP**
Cat. No. 1535TPF **TPF** ■



ALSO AVAILABLE:
HYBRID INTERIOR
TREKPAK™ & PICK N PLUCK™

Check with airline for exact measurement requirements.

1555

INTERNAL DIMS:
23.00" x 12.75" x 7.50"
(58.4 x 32.4 x 19.1 cm)

EXTERNAL DIMS:
24.76" x 15.46" x 8.24"
(62.9 x 39.3 x 20.9 cm)

■ ■ ■ ■ ■
Cat. No. 1555 **WF**
Cat. No. 1555NF **NF**
Cat. No. 1555WD **WD**
Cat. No. 1555TP **TP**



1607



INTERNAL DIMS:
21.05" x 15.81" x 11.63"
(53.5 x 40.2 x 29.5 cm)

EXTERNAL DIMS:
24.13" x 18.80" x 13.25"
(61.3 x 47.8 x 33.7 cm)

■ ■ ■ ■ ■
Cat. No. 1607 **WF**
Cat. No. 1607NF **NF**
Cat. No. 1607WD **WD**



1745



NEW

INTERNAL DIMS:
44.01" x 16.77" x 7.94"
(111.8 x 42.6 x 20.2 cm)

EXTERNAL DIMS:
46.69" x 19.36" x 8.73"
(118.6 x 49.2 x 22.2 cm)

■
Cat. No. 1745 **WF**
Cat. No. 1745NF **NF**



1557

INTERNAL DIMS:
17.33" x 13.00" x 9.75"
(44.0 x 33.0 x 24.8 cm)

EXTERNAL DIMS:
19.18" x 15.79" x 10.50"
(48.7 x 40.1 x 26.7 cm)

■ ■ ■ ■ ■
Cat. No. 1557 **WF**
Cat. No. 1557NF **NF**
Cat. No. 1557WD **WD**
Cat. No. 1557TP **TP**



1615 WHEELED CHECK-IN



INTERNAL DIMS:
29.59" x 15.50" x 9.38"
(75.2 x 39.4 x 23.8 cm)

EXTERNAL DIMS:
32.58" x 18.40" x 11.02"
(82.8 x 46.7 x 28 cm)

■ ■ ■ ■ ■
Cat. No. 1615 **WF**
Cat. No. 1615NF **NF**
Cat. No. 1615WD **WD**
Cat. No. 1615TP **TP**



Check with airline for exact measurement requirements.

1745BOW



NEW

INTERNAL DIMS:
44.01" x 16.77" x 7.94"
(111.8 x 42.6 x 20.2 cm)

EXTERNAL DIMS:
46.69" x 19.36" x 8.73"
(118.6 x 49.2 x 22.2 cm)

■
Cat. No. 1745BOW
Case with custom configured
interior for bowhunters.
Bow and arrows not included.



1605

INTERNAL DIMS:
26.00" x 14.00" x 8.38"
(66 x 35.6 x 21.3 cm)

EXTERNAL DIMS:
28.87" x 16.77" x 9.12"
(73.3 x 42.6 x 23.2 cm)

■ ■ ■ ■ ■
Cat. No. 1605 **WF**
Cat. No. 1605NF **NF**
Cat. No. 1605WD **WD**
Cat. No. 1605TP **TP**



1637



INTERNAL DIMS:
23.43" x 17.55" x 13.25"
(59.5 x 44.6 x 33.7 cm)

EXTERNAL DIMS:
26.61" x 20.65" x 14.87"
(67.6 x 52.5 x 37.8 cm)

■ ■ ■ ■ ■
Cat. No. 1637 **WF**
Cat. No. 1637NF **NF**
Cat. No. 1637WD **WD**



Icon indicates select models with wheels





PELICAN™ PERSONAL UTILITY CASE SERIES

PELICAN RUCK™ CASE

- OUTSIDE:**
- IP68 PROTECTION FROM DIRT, WATER, SNOW, DUST
 - RUBBER EXO-SKELETON
 - DUAL PIVOT LATCH
 - MULTIPLE EXTERNAL ATTACHMENT POINTS
- INSIDE:**
- SNAP IN, FLEXIBLE LID ORGANIZER
 - LOOP SYSTEM WITH VELCRO® BRAND STRAPS
 - CABLE ROUTING HOLE
 - RIGID DIVIDER TRAY



R20 PELICAN RUCK™ CASE

NEW

INTERNAL DIMS:
7.07" x 3.39" x 1.95"
(18 x 8.6 x 5 cm)

EXTERNAL DIMS:
8.96" x 4.83" x 2.88"
(22.8 x 12.3 x 7.3 cm)

■ ■ ■ ■
Cat. No. R20



R40 PELICAN RUCK™ CASE

NEW

INTERNAL DIMS:
7.63" x 4.70" x 1.90"
(19.4 x 11.9 x 4.8 cm)

EXTERNAL DIMS:
9.84" x 6.12" x 2.89"
(25 x 15.5 x 7.3 cm)

■ ■ ■ ■
Cat. No. R40



R60 PELICAN RUCK™ CASE

NEW

INTERNAL DIMS:
8.90" x 5.37" x 2.96"
(22.6 x 13.6 x 7.5 cm)

EXTERNAL DIMS:
11.14" x 6.86" x 3.88"
(28.3 x 17.4 x 9.9 cm)

■ ■ ■ ■
Cat. No. R60



PELICAN GO™ CASE

- OUTSIDE:**
- IP67 PROTECTION FROM DIRT, WATER, SNOW, DUST
 - RUBBERIZED PROTECTIVE BUMPER
 - SINGLE LATCH CLOSURE
 - EASY CARRY HANDLE
 - WATERTIGHT SEAL
- INSIDE:**
- ORGANIZING SYSTEM FOR CARDS (G40 ONLY)
 - CABLE ROUTING HOLE
 - RIGID DIVIDER TRAY

G10 PELICAN GO™ CASE

NEW

INTERNAL DIMS:
4.80" x 2.80" x 1.60"
(12.2 x 7.1 x 4.1 cm)

EXTERNAL DIMS:
7.05" x 4.37" x 1.81"
(17.9 x 11.1 x 4.6 cm)

■ ■ ■ ■ ■ ■ ■ ■
Cat. No. G10



G40 PELICAN GO™ CASE

NEW

INTERNAL DIMS:
7.00" x 3.50" x 1.60"
(17.8 x 8.9 x 4.1 cm)

EXTERNAL DIMS:
9.45" x 5.06" x 2.05"
(24 x 12.9 x 5.2 cm)

■ ■ ■ ■ ■ ■ ■ ■
Cat. No. G40





PELICAN™ PROTECTOR CASE™ SERIES

PROTECT WHAT MATTERS WITH MILITARY GRADE PROTECTION

No matter the job, the Pelican™ Protector Case™ is the standard in offering your equipment the protection it needs and deserves.



PELICAN™ PROTECTOR CASE™ COLORS AVAILABLE

*Not available in all case sizes.



SOLID CONSTRUCTION

The Pelican™ Protector Case™ uses an open cell core and solid wall construction, which is actually stronger and lighter than a solid core wall. Travel light with heavy protection.

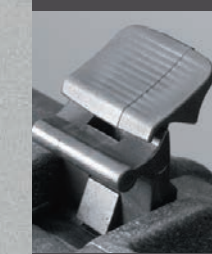

DOUBLE-THROW LATCHES

Double-Throw latches are smarter and easier to open: it's the classic 'C' clamp design with a secondary movement that works like a pry bar to start the release and offers plenty of leverage to open with a light pull.



WATERTIGHT

The secret is the tongue-and-groove fit with a polymer o-ring acting as a waterproof seal. Also, our Automatic Pressure Equalization Valve releases built-up air pressure while keeping water molecules out, resulting in a watertight case that is easy to open.



EASY RIDING

Stainless steel ball bearing wheels (on select cases) last longer and ride smoother. The nylon hub adjacent to the stainless steel resists heat resulting in less wear and tear on the polyurethane tire.



TESTED

The Pelican™ Case design is the result of multiple generations of refinement. This evolution is proven through submergence and other lab tests.

MEMORY CARD & MICRO CASES

From small sensitive components to smartphones, protect your gear from the elements in a Memory Card Case or Micro Case from Pelican.



0915 CASE

INTERNAL DIMS:
4.79" x 2.25" x 0.55"
(12.2 x 5.7 x 1.4cm)

EXTERNAL DIMS:
5.55" x 3.27" x 0.85"
(14.1 x 8.3 x 2.2cm)



Cat. No. 0915

Stores 12 SD cards or 6 mini SD cards and 6 micro SD cards.



0945 CASE

INTERNAL DIMS:
4.79" x 2.25" x 0.55"
(12.2 x 5.7 x 1.4 cm)

EXTERNAL DIMS:
5.55" x 3.27" x 0.85"
(14.1 x 8.3 x 2.2 cm)



Cat. No. 0945

Stores 6 compact flash cards.



0955 CASE

INTERNAL DIMS:
4.79" x 2.25" x 0.55"
(12.2 x 5.7 x 1.4 cm)

EXTERNAL DIMS:
5.55" x 3.27" x 0.85"
(14.1 x 8.3 x 2.2cm)



Cat. No. 0955

Holds keys, ID, cards and cash.



1010 MICRO CASE

INTERNAL DIMS:
4.37" x 2.87" x 1.68"
(11.1 x 7.3 x 4.3 cm)

EXTERNAL DIMS:
5.88" x 4.06" x 2.12"
(14.9 x 10.3 x 5.4 cm)

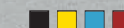

Cat. No. 1010

Available in clear with a colored rubber liner or in solid colors with a black rubber liner. Pick N Pluck™ foam inserts are available.



1020 MICRO CASE

INTERNAL DIMS:
5.31" x 3.56" x 1.68"
(13.5 x 9 x 4.3 cm)

EXTERNAL DIMS:
6.82" x 4.75" x 2.12"
(17.3 x 12.1 x 5.4 cm)

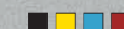

Cat. No. 1020

Available in clear with a colored rubber liner or in solid colors with a black rubber liner. Pick N Pluck™ foam inserts are available.



1040 MICRO CASE

INTERNAL DIMS:
6.50" x 3.87" x 1.75"
(16.5 x 9.8 x 4.4 cm)

EXTERNAL DIMS:
7.50" x 5.06" x 2.12"
(19.1 x 12.9 x 5.4 cm)

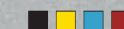

Cat. No. 1040

Available in clear with a colored rubber liner or in solid colors with a black rubber liner. Pick N Pluck™ foam inserts are available.



1015 MICRO CASE

INTERNAL DIMS:
5.14" x 2.64" x 1.37"
(13.1 x 6.7 x 3.5 cm)

EXTERNAL DIMS:
6.68" x 3.88" x 1.86"
(17 x 9.9 x 4.7 cm)



Cat. No. 1015

Available in clear with a colored rubber liner or in solid colors with a black rubber liner. Pick N Pluck™ foam inserts are available.



1030 MICRO CASE

INTERNAL DIMS:
6.37" x 2.62" x 2.06"
(16.2 x 6.7 x 5.2)

EXTERNAL DIMS:
7.50" x 3.87" x 2.43"
(19.1 x 9.8 x 6.2 cm)

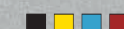

Cat. No. 1030

Available in clear with a colored rubber liner or in solid colors with a black rubber liner. Pick N Pluck™ foam inserts are available.



1050 MICRO CASE

INTERNAL DIMS:
6.31" x 3.68" x 2.75"
(16 x 9.3 x 7 cm)

EXTERNAL DIMS:
7.50" x 5.06" x 3.12"
(19.1 x 12.9 x 7.9 cm)



Cat. No. 1050

Available in clear with a colored rubber liner or in solid colors with a black rubber liner. Pick N Pluck™ foam inserts are available.



1060 MICRO CASE

INTERNAL DIMS:
8.25" x 4.25" x 2.25"
(21 x 10.8 x 5.7 cm)

EXTERNAL DIMS:
9.37" x 5.56" x 2.62"
(23.8 x 14.1 x 6.7 cm)



Cat. No. 1060

Available in clear with a colored rubber liner or in solid colors with a black rubber liner. Pick N Pluck™ foam inserts are available.



SMALL CASES

Lightweight, but extremely strong; compact, yet fully capable. Perfect for valuable gear like hand tools and small to medium electronic components, hand held GPS systems, and DSLR cameras. All small cases are available empty or with pre-scored Pick N Pluck™ foam.



1120

INTERNAL DIMS:
7.29" x 4.78" x 3.33"
(18.5 x 12.1 x 8.5 cm)

EXTERNAL DIMS:
8.41" x 6.76" x 3.87"
(21.4 x 17.2 x 9.8 cm)



Cat. No. 1120 **WF**
Cat. No. 1120**NF** **NF**



1150

INTERNAL DIMS:
8.29" x 5.79" x 3.75"
(21.1 x 14.7 x 9.5 cm)

EXTERNAL DIMS:
9.44" x 7.80" x 4.29"
(24 x 19.8 x 10.9 cm)



Cat. No. 1150 **WF**
Cat. No. 1150**NF** **NF**



1170

INTERNAL DIMS:
10.54" x 6.04" x 3.16"
26.8 x 15.3 x 8 cm)

EXTERNAL DIMS:
11.64" x 8.34" x 3.78"
(29.6 x 21.2 x 9.6 cm)



Cat. No. 1170 **WF**
Cat. No. 1170**NF** **NF**



1200

INTERNAL DIMS:
9.25" x 7.12" x 4.12"
(23.5 x 18.1 x 10.5 cm)

EXTERNAL DIMS:
10.62" x 9.68" x 4.87"
(27 x 24.6 x 12.4 cm)



Cat. No. 1200 **WF**
Cat. No. 1200**NF** **NF**



1300

INTERNAL DIMS:
9.17" x 7.00" x 6.12"
(23.3 x 17.8 x 15.5 cm)

EXTERNAL DIMS:
10.62" x 9.68" x 6.87"
(27 x 24.6 x 17.4 cm)



Cat. No. 1300 **WF**
Cat. No. 1300**NF** **NF**



1400

INTERNAL DIMS:
11.81" x 8.87" x 5.18"
(30 x 22.5 x 13.2 cm)

EXTERNAL DIMS:
13.37" x 11.62" x 6.00"
(34 x 29.5 x 15.2 cm)



Cat. No. 1400 **WF**
Cat. No. 1400**NF** **NF**



DIGITAL SURVIVAL CASES

The ultimate in watertight, crushproof, and impact protected cases to transport your small electronics and other vital gear, anywhere on Earth. Digital survival cases provide the peace of mind and protection your laptops and tablets need.



1055CC

INTERNAL DIMS:
8.55" x 5.52" x 0.85"
(21.7 x 14 x 2.2 cm)

EXTERNAL DIMS:
9.42" x 7.02" x 1.24"
(23.9 x 17.8 x 3.1 cm)



Cat. No. 1055CC
† Designed to protect most 7" tablets and eReaders.



1065CC

INTERNAL DIMS:
9.96" x 7.76" x 0.81"
(25.3 x 19.7 x 2.1 cm)

EXTERNAL DIMS:
10.86" x 9.28" x 1.24"
(27.6 x 23.6 x 3.1 cm)



Cat. No. 1065CC
† Designed to protect most 10" tablets.



1070CC

INTERNAL DIMS:
12.80" x 8.95" x 0.72"
(32.5 x 22.7 x 1.8 cm)

EXTERNAL DIMS:
15.29" x 11.96" x 1.6"
(38.8 x 30.4 x 4.1 cm)



Cat. No. 1070CC
† Designed to fit 13" Ultrabook™ laptops.



1075

INTERNAL DIMS:
11.11" x 7.92" x 1.63"
(28.2 x 20.1 x 4.1 cm)

EXTERNAL DIMS:
12.38" x 9.75" x 2.13"
(31.4 x 24.8 x 5.4 cm)



*Cat. No. 1075 **WF**
† Designed to protect various electronic devices including external hard drives.



1075CC

INTERNAL DIMS:
11.11" x 7.92" x 1.63"
(28.2 x 20.1 x 4.1 cm)

EXTERNAL DIMS:
12.38" x 9.75" x 2.13"
(31.4 x 24.8 x 5.4 cm)



Cat. No. 1075CC
(with netbook liner)
† Designed to protect most popular netbooks up to 11.3" x 8.1" x 1.6"



† CHECK DEVICE DIMENSIONS TO ENSURE CORRECT CASE SIZE

P1075

INTERNAL DIMS:
11.11" x 7.92" x 1.63"
(28.2 x 20.1 x 4.1 cm)

EXTERNAL DIMS:
12.38" x 9.75" x 2.13"
(31.4 x 24.8 x 5.4 cm)



■ ***Cat. No. P1075 WF**
† Designed to fit pistols, revolvers and magazines.

1085

INTERNAL DIMS:
14.29" x 10.37" x 1.97"
(36.3 x 26.3 x 5 cm)

EXTERNAL DIMS:
15.64" x 12.41" x 2.50"
(39.7 x 31.5 x 6.4 cm)



■ ***Cat. No. 1085 WF**
† Designed to protect 14" laptops.

1085CC

INTERNAL DIMS:
14.29" x 10.37" x 1.97"
(36.3 x 26.3 x 5 cm)

EXTERNAL DIMS:
15.64" x 12.41" x 2.50"
(39.7 x 31.5 x 6.4 cm)



■ **Cat. No. 1085CC**
(with laptop liner)
† Designed to protect 14" laptops.

1495

INTERNAL DIMS:
18.87" x 13.12" x 3.81"
(47.9 x 33.3 x 9.7 cm)

EXTERNAL DIMS:
21.62" x 17.25" x 4.87"
(54.9 x 43.8 x 12.4 cm)



■ ■ **Cat. No. 1495 WF**
Cat. No. 1495NF NF

1495CC1

INTERNAL DIMS:
18.87" x 13.12" x 3.81"
(47.9 x 33.3 x 9.7 cm)

EXTERNAL DIMS:
21.62" x 17.25" x 4.87"
(54.9 x 43.8 x 12.4 cm)



■ ■ **Cat. No. 1495CC1**
Case with lid organizer, shock absorbing tray, nylon padded computer sleeve, accessories pouch, and removable shoulder strap.

1095

INTERNAL DIMS:
15.78" x 11.16" x 2.06"
(40.1 x 28.3 x 5.2 cm)

EXTERNAL DIMS:
17.18" x 13.24" x 2.60"
(43.6 x 33.6 x 6.6 cm)



■ ***Cat. No. 1095 WF**
† Designed to protect 15" laptops.

1095CC

INTERNAL DIMS:
15.78" x 11.16" x 2.06"
(40.1 x 28.3 x 5.2 cm)

EXTERNAL DIMS:
17.18" x 13.24" x 2.60"
(43.6 x 33.6 x 6.6 cm)



■ **Cat. No. 1095CC**
(with laptop liner)
† Designed to protect 15" laptops.

1470

INTERNAL DIMS:
15.70" x 10.70" x 3.87"
(39.9 x 27.2 x 9.8 cm)

EXTERNAL DIMS:
16.88" x 13.23" x 4.47"
(42.9 x 33.6 x 11.4 cm)



■ ■ **Cat. No. 1470 WF**
Cat. No. 1470NF NF

1495CC2

INTERNAL DIMS:
18.87" x 13.12" x 3.81"
(47.9 x 33.3 x 9.7 cm)

EXTERNAL DIMS:
21.62" x 17.25" x 4.87"
(54.9 x 43.8 x 12.4 cm)



■ ■ **Cat. No. 1495CC2**
Case with lid organizer, Pick N Pluck™ foam, and removable shoulder strap.

1430 TOP LOADER

INTERNAL DIMS:
13.56" x 5.76" x 11.70"
(34.4 x 14.6 x 29.7 cm)

EXTERNAL DIMS:
16.40" x 8.71" x 13.15"
(41.7 x 22.1 x 33.4 cm)



■ ■ ■ ■ ■ **Cat. No. 1430 WF**
Cat. No. 1430NF NF
Cat. No. 1434 (with padded divider and lid organizer)
Cat. No. 1437 (with padded office divider and lid organizer)

1490

INTERNAL DIMS:
17.75" x 11.37" x 4.12"
(45.1 x 28.9 x 10.5 cm)

EXTERNAL DIMS:
19.87" x 13.93" x 4.68"
(50.5 x 35.4 x 11.9 cm)



■ ■ **Cat. No. 1490 WF**
Cat. No. 1490NF NF

1490CC1

INTERNAL DIMS:
17.75" x 11.37" x 4.12"
(45.1 x 28.9 x 10.5 cm)

EXTERNAL DIMS:
19.87" x 13.93" x 4.68"
(50.4 x 35.4 x 11.9 cm)



■ ■ ■ **Cat. No. 1490CC1**
Case with lid organizer, fitted shock absorbing tray, and removable shoulder strap.

1490CC2

INTERNAL DIMS:
17.75" x 11.37" x 4.12"
(45.1 x 28.9 x 10.5 cm)

EXTERNAL DIMS:
19.87" x 13.93" x 4.68"
(50.5 x 35.4 x 11.9 cm)



■ ■ ■ **Cat. No. 1490CC2**
Case with lid organizer, Pick N Pluck™ foam, and removable shoulder strap.

1440 TOP LOADER

INTERNAL DIMS:
17.10" x 7.50" x 16.00"
(43.4 x 19.1 x 40.6 cm)

EXTERNAL DIMS:
19.70" x 12.00" x 18.00"
(50 x 30.5 x 45.7 cm)



■ ■ ■ ■ ■ **Cat. No. 1440 WF**
Cat. No. 1440NF NF
Cat. No. 1444 (with utility padded divider and lid organizer)
Cat. No. 1447 (with padded office divider and lid organizer)



MEDIUM CASES

Mobility with room for protecting larger gear or multiple instruments and accessories. Interior options are available for extra protection. Select models meet carry-on luggage specifications. Most cases are available empty, with foam, padded dividers or TrekPak™ dividers. See chart on page 31.



Icon indicates select models with wheels

1450

INTERNAL DIMS:
14.66" x 10.24" x 6.12"
(37.2 x 26 x 15.5 cm)

EXTERNAL DIMS:
16.44" x 13" x 6.82"
(41.8 x 33 x 17.3 cm)

■ ■ ■ ■ ■ *

Cat. No. 1450 WF
Cat. No. 1450NF NF
Cat. No. 1454 WD



1460

INTERNAL DIMS:
18.54" x 9.92" x 10.92"
(47.1 x 25.2 x 27.7cm)

EXTERNAL DIMS:
20.85" x 12.73" x 12.75"
(53 x 32.3 x 32.4 cm)

■ ■ ■ *

Cat. No. 1460 WF
Cat. No. 1460NF NF
Cat. No. 1460AALG
Includes custom foam for 9430/9435.



1460 TOOL CASE

INTERNAL DIMS:
18.54" x 9.92" x 10.92"
(47.1 x 25.2 x 27.7cm)

EXTERNAL DIMS:
20.85" x 12.73" x 12.75"
(53 x 32.3 x 32.4 cm)

■ ■ ■

Cat. No. 1460TOOL
Case with adjustable and removable tray dividers for easy customization.



1460 EMS

INTERNAL DIMS:
18.54" x 9.92" x 10.92"
(47.1 x 25.2 x 27.7 cm)

EXTERNAL DIMS:
20.85" x 12.73" x 12.75"
(53 x 32.3 x 32.4 cm)

■ ■ ■

Cat. No. 1460EMS
Case with custom configured lid organizer and trays for EMS professionals.



1500

INTERNAL DIMS:
16.75" x 11.18" x 6.12"
(42.5 x 28.4 x 15.5 cm)

EXTERNAL DIMS:
18.50" x 14.06" x 6.93"
(47 x 35.7 x 17.6 cm)

■ ■ ■ ■ ■ ■ *

Cat. No. 1500 WF
Cat. No. 1500NF NF
Cat. No. 1504 WD



1500 EMS

INTERNAL DIMS:
16.75" x 11.18" x 6.12"
(42.5 x 28.4 x 15.5 cm)

EXTERNAL DIMS:
18.50" x 14.06" x 6.93"
(47 x 35.7 x 17.6 cm)

■ ■ ■ ■

Cat. No. 1500EMS
Case with custom configured lid organizer and trays for EMS professionals.



1510 LOC

INTERNAL DIMS:
19.75" x 11.00" x 7.60"
(50.2 x 27.9 x 19.3 cm)

EXTERNAL DIMS:
22.00" x 13.81" x 9.00"
(55.9 x 35.1 x 22.9 cm)

■ ■ ■ *

Cat. No. 1510LOC
Case with fully enclosed apparel insert, padded laptop sleeve, and accessory pouch.



1520

INTERNAL DIMS:
18.06" x 12.89" x 6.72"
(45.9 x 32.7 x 17.1 cm)

EXTERNAL DIMS:
19.78" x 15.77" x 7.41"
(50.2 x 40.1 x 18.8 cm)

■ ■ ■ ■ ■ ■ *

Cat. No. 1520 WF
Cat. No. 1520NF NF
Cat. No. 1524 WD
Cat. No. 1526
1520 Case with 1527 Convertible Travel Bag.



1510 WHEELED CARRY-ON

INTERNAL DIMS:
19.75" x 11.00" x 7.60"
(50.2 x 27.9 x 19.3 cm)

EXTERNAL DIMS:
22.00" x 13.81" x 9.00"
(55.9 x 35.1 x 22.9 cm)

■ ■ ■ *

Cat. No. 1510 WF
Cat. No. 1510NF NF
Cat. No. 1514 WD
Cat. No. 1510TP TP
Cat. No. 1510TPF TPF
Check with airline for exact measurement requirements.



AVAILABLE:
HYBRID INTERIOR
TREKPAK™ & PICK N PLUCK™

1510 SC

INTERNAL DIMS:
19.75" x 11.00" x 7.60"
(50.2 x 27.9 x 19.3 cm)

EXTERNAL DIMS:
22.00" x 13.81" x 9.00"
(55.9 x 35.1 x 22.9 cm)

■ ■ ■ *

Cat. No. 1510SC
Case with padded dividers, padded laptop sleeve, and accessory pouch.



1510M

INTERNAL DIMS:
19.75" x 11.00" x 7.60"
(50.2 x 27.9 x 19.3 cm)

EXTERNAL DIMS:
23.55" x 14.36" x 10.62"
(59.8 x 36.5 x 27 cm)

■

Cat. No. 1510M WF
Cat. No. 1510MNF NF
Mobility version features 2 oversized wheels for use on rough terrain.



1510 LFC

INTERNAL DIMS:
19.75" x 11.00" x 7.60"
(50.2 x 27.9 x 19.3 cm)

EXTERNAL DIMS:
22.00" x 13.81" x 9.00"
(55.9 x 35.1 x 22.9 cm)

■ ■ ■ *

Cat. No. 1510LFC
Case with Pick N Pluck™ foam, padded laptop sleeve, and accessory pouch.



1550 EMS

INTERNAL DIMS:
18.43" x 14.00" x 7.62"
(46.8 x 35.6 x 19.4 cm)

EXTERNAL DIMS:
20.62" x 16.87" x 8.12"
(52.4 x 42.8 x 20.6 cm)

■ ■ ■ ■

Cat. No. 1550EMS
Case with custom configured lid organizer and trays for EMS professionals.



LARGE CASES

Designed for extreme protection during transport and storage. Customizable interiors allow for extra protection and inventory control. Select models feature retractable handles, extra wide grips and sturdy casters for efficient mobility.



Icon indicates select models with wheels



1560

INTERNAL DIMS:
19.92" x 14.98" x 9.00"
(50.6 x 38 x 22.9 cm)

EXTERNAL DIMS:
22.07" x 17.92" x 10.42"
(56.1 x 45.5 x 26.5 cm)

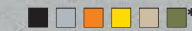

Cat. No. 1560 WF
Cat. No. 1560NF NF
Cat. No. 1564 WD
Cat. No. 1560TP TP



1560M

INTERNAL DIMS:
19.92" x 14.98" x 9.00"
(50.6 x 38 x 22.9 cm)

EXTERNAL DIMS:
23.78" x 18.33" x 12.08"
(60.4 x 46.6 x 30.7 cm)



Cat. No. 1560M WF
Cat. No. 1560MNF NF
Mobility version features 2 oversized wheels for use on rough terrain.



1560LOC

INTERNAL DIMS:
19.92" x 14.98" x 9.00"
(50.6 x 38 x 22.9 cm)

EXTERNAL DIMS:
22.07" x 17.92" x 10.42"
(56.1 x 45.5 x 26.5 cm)



Cat. No. 1560LOC
Case with fully enclosed apparel insert, padded laptop sleeve, and accessory pouch.



1560SC

INTERNAL DIMS:
19.92" x 14.98" x 9.00"
(50.6 x 38 x 22.9 cm)

EXTERNAL DIMS:
22.07" x 17.92" x 10.42"
(56.1 x 45.5 x 26.5 cm)



Cat. No. 1560SC
Case with padded dividers, padded laptop sleeve, and accessory pouch.



1560LFC

INTERNAL DIMS:
19.92" x 14.98" x 9.00"
(50.6 x 38 x 22.9 cm)

EXTERNAL DIMS:
22.07" x 17.92" x 10.42"
(56.1 x 45.5 x 26.5 cm)



Cat. No. 1560LFC
Case with Pick N Pluck™ foam, padded laptop sleeve, and accessory pouch.



1600

INTERNAL DIMS:
21.51" x 16.54" x 7.99"
(54.6 x 42 x 20.3 cm)

EXTERNAL DIMS:
24.39" x 19.36" x 8.79"
(62 x 49.2 x 22.3 cm)



Cat. No. 1600 WF
Cat. No. 1600NF NF
Cat. No. 1604 WD
Cat. No. 1600TP TP



1600 EMS

INTERNAL DIMS:
21.51" x 16.54" x 7.99"
(54.6 x 42 x 20.3 cm)

EXTERNAL DIMS:
24.39" x 19.36" x 8.79"
(62 x 49.2 x 22.3 cm)



Cat. No. 1600EMS
Case with custom configured lid organizer and trays for EMS professionals.



1610

INTERNAL DIMS:
21.78" x 16.69" x 10.62"
(55.3 x 42.4 x 27 cm)

EXTERNAL DIMS:
24.83" x 19.69" x 11.88"
(63.1 x 50 x 30.2 cm)



Cat. No. 1610 WF
Cat. No. 1610NF NF
Cat. No. 1614 WD
Cat. No. 1610TP TP



1610M

INTERNAL DIMS:
21.78" x 16.69" x 10.62"
(55.3 x 42.4 x 27 cm)

EXTERNAL DIMS:
26.20" x 23.00" x 13.68"
(66.5 x 58.4 x 34.7 cm)



Cat. No. 1610M WF
Cat. No. 1610MNF NF
Mobility version features 2 oversized wheels for use on rough terrain.



1620

INTERNAL DIMS:
21.48" x 16.42" x 12.54"
(54.6 x 41.7 x 31.9 cm)

EXTERNAL DIMS:
24.76" x 19.57" x 13.90"
(62.9 x 49.7 x 35.3 cm)

■ ■ ■ *

Cat. No. 1620 **WF**
Cat. No. 1620**NF** **NF**
Cat. No. 1624 **WD**



1620M

INTERNAL DIMS:
21.48" x 16.42" x 12.54"
(54.6 x 41.7 x 31.9 cm)

EXTERNAL DIMS:
26.20" x 23.00" x 15.61"
(66.5 x 58.4 x 39.6 cm)

■

Cat. No. 1620**M** **WF**
Cat. No. 1620**MNF** **NF**
Mobility version features 2 oversized wheels for use on rough terrain.



1630

INTERNAL DIMS:
27.70" x 20.98" x 15.50"
(70.4 x 53.3 x 39.4 cm)

EXTERNAL DIMS:
31.28" x 24.21" x 17.48"
(79.5 x 61.5 x 44.4 cm)

■ ■ ■ *

Cat. No. 1630 **WF**
Cat. No. 1630**NF** **NF**
Cat. No. 1634 **WD**



1780

INTERNAL DIMS:
41.12" x 21.54" x 14.88"
(104.4 x 54.7 x 37.8 cm)

EXTERNAL DIMS:
44.90" x 25.32" x 16.50"
(114 x 64.3 x 41.9 cm)

■ ■ ■ *

Cat. No. 1780 **WF**
Cat. No. 1780**NF** **NF**



0340

INTERNAL DIMS:
18.00" x 18.00" x 18.00"
(45.7 x 45.7 x 45.7 cm)

EXTERNAL DIMS:
20.50" x 20.50" x 19.25"
(52.1 x 52.1 x 48.9 cm)

■ ■ ■ *

Cat. No. 0340 **WF**
Cat. No. 0340**NF** **NF**
Cat. No. 0344 **WD**



0350

INTERNAL DIMS:
20.00" x 20.00" x 20.00"
(50.8 x 50.8 x 50.8 cm)

EXTERNAL DIMS:
22.50" x 22.43" x 21.25"
(57.2 x 57 x 54 cm)

■ ■ ■ *

Cat. No. 0350 **WF**
Cat. No. 0350**NF** **NF**
Cat. No. 0354 **WD**



1640

INTERNAL DIMS:
23.70" x 24.00" x 13.90"
(60.2 x 61 x 35.3 cm)

EXTERNAL DIMS:
27.20" x 27.50" x 16.30"
(69.1 x 69.9 x 41.4 cm)

■ ■ ■ *

Cat. No. 1640 **WF**
Cat. No. 1640**NF** **NF**
Cat. No. 1644 **WD**



1650

INTERNAL DIMS:
28.57" x 17.52" x 10.65"
(72.6 x 44.5 x 27.1 cm)

EXTERNAL DIMS:
31.59" x 20.47" x 12.45"
(80.2 x 52 x 31.6 cm)

■ ■ ■ *

Cat. No. 1650 **WF**
Cat. No. 1650**NF** **NF**
Cat. No. 1654 **WD**
Cat. No. 1650**TP** **TP**



1660

INTERNAL DIMS:
28.20" x 19.66" x 17.63"
(71.6 x 49.9 x 44.8 cm)

EXTERNAL DIMS:
31.59" x 22.99" x 19.48"
(80.2 x 58.4 x 49.5 cm)

■ ■ ■ *

Cat. No. 1660 **WF**
Cat. No. 1660**NF** **NF**
Cat. No. 1664 **WD**

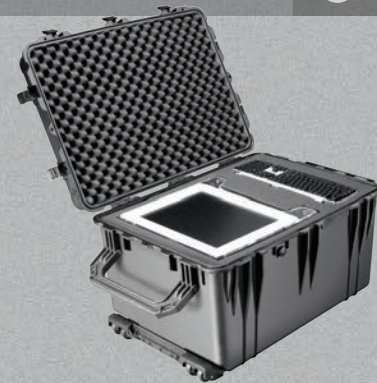

0370

INTERNAL DIMS:
24.00" x 24.00" x 24.00"
(61 x 61 x 61 cm)

EXTERNAL DIMS:
26.50" x 26.50" x 25.25"
(67.3 x 67.3 x 64.1 cm)

■ ■ ■ *

Cat. No. 0370 **WF**
Cat. No. 0370**NF** **NF**
Cat. No. 0374 **WD**



0450

INTERNAL DIMS:
Varies by drawer configuration.

EXTERNAL DIMS:
23.95" x 14.75" x 17.95"
(60.8 x 37.5 x 45.6 cm)

■

Cat. No. 0450**SD4**
(4 shallow + 2 deep drawers)
Cat. No. 0450**SD6**
(6 shallow + 1 deep drawer)



1670

INTERNAL DIMS:
28.10" x 16.49" x 9.19"
(71.4 x 41.9 x 23.3 cm)

EXTERNAL DIMS:
31.04" x 19.39" x 11.17"
(78.8 x 49.3 x 28.4 cm)

■ ■ ■ *

Cat. No. 1670 **WF**
Cat. No. 1674 **WD**
Mobility design features 4 extra-wide wheels and 2 extra-wide handles.



1690

INTERNAL DIMS:
30.13" x 25.13" x 15.36"
(76.5 x 63.8 x 39 cm)

EXTERNAL DIMS:
33.43" x 28.40" x 17.65"
(84.9 x 72.1 x 44.8 cm)

■ ■ ■ *

Cat. No. 1690 **WF**
Cat. No. 1690**NF** **NF**
Cat. No. 1694 **WD**



1730

INTERNAL DIMS:
34.00" x 24.00" x 12.50"
(86.4 x 61 x 31.8 cm)

EXTERNAL DIMS:
37.05" x 27.20" x 14.37"
(94.1 x 69.1 x 36.5 cm)

■ ■ ■ *

Cat. No. 1730 **WF**
Cat. No. 1730**NF** **NF**



0500

INTERNAL DIMS:
34.95" x 18.45" x 25.25"
(88.8 x 46.9 x 64.1 cm)

EXTERNAL DIMS:
39.95" x 23.45" x 28.65"
(101.5 x 59.6 x 72.8 cm)

■

Cat. No. 0500 **WF**
Cat. No. 0500**NF** **NF**



0550

INTERNAL DIMS:
47.57" x 24.07" x 17.68"
(120.8 x 61.1 x 44.9 cm)

EXTERNAL DIMS:
51.05" x 27.54" x 22.79"
(129.7 x 70 x 57.9 cm)

■

Cat. No. 0550 **WF**
Cat. No. 0550**NF** **NF**



SHOWN WITH OPTIONAL CASTER WHEELS



LONG CASES

Ideal for weapons, but are also used by industrial workers for instruments and gear. Equipped with sturdy polyurethane wheels for ease of transport. All Long Cases are available empty or with solid foam (not Pick N Pluck™ foam). See chart on page 31.



Icon indicates select models with wheels



1700



INTERNAL DIMS:
35.75" x 13.50" x 5.25"
(90.8 x 34.3 x 13.3 cm)

EXTERNAL DIMS:
38.12" x 16.00" x 6.12"
(96.8 x 40.6 x 15.5 cm)

■ ■ ■ *

Cat. No. 1700 **WF**
Cat. No. 1700NF **NF**



1720



INTERNAL DIMS:
42.00" x 13.50" x 5.25"
(106.7 x 34.3 x 13.3 cm)

EXTERNAL DIMS:
44.37" x 16.00" x 6.12"
(112.7 x 40.6 x 15.5 cm)

■ ■ ■ *

Cat. No. 1720 **WF**
Cat. No. 1720NF **NF**



1740



INTERNAL DIMS:
40.98" x 12.92" x 12.13"
(104.1 x 32.8 x 30.8 cm)

EXTERNAL DIMS:
44.16" x 16.09" x 14.00"
(112.2 x 40.9 x 35.6 cm)

■ ■ ■ *

Cat. No. 1740 **WF**
Cat. No. 1740NF **NF**



1750



INTERNAL DIMS:
50.50" x 13.50" x 5.25"
(128.2 x 34.3 x 13.3 cm)

EXTERNAL DIMS:
53.00" x 16.00" x 6.12"
(134.6 x 40.6 x 15.5 cm)

■

Cat. No. 1750 **WF**
Cat. No. 1750NF **NF**



1770



INTERNAL DIMS:
54.58" x 15.58" x 8.63"
(138.6 x 39.6 x 21.9 cm)

EXTERNAL DIMS:
57.42" x 18.48" x 11.23"
(145.8 x 46.9 x 28.5 cm)

■ ■

Cat. No. 1770 **WF**
Cat. No. 1770NF **NF**



1780HL



INTERNAL DIMS:
41.12" x 21.54" x 14.88"
(104.4 x 54.7 x 37.8 cm)

EXTERNAL DIMS:
44.90" x 25.32" x 16.50"
(114 x 64.3 x 41.9 cm)

■ ■ ■ *

Cat. No. 1780HL
(rifle hard liner insert)
Cat. No. 1780RF
(rifle foam cut insert)





PELICAN™ STORM CASE™ SERIES

PROFESSIONAL-GRADE PROTECTION WITH EASY-TO-USE LATCHES

The Pelican™ Storm Case™ series combines our ultra sleek, professional-grade design with easy-to-use, self locking, Press and Pull latches for protection and convenience.



PELICAN™ STORM CASE™ COLORS AVAILABLE

*Not available in all case sizes.



BLACK



YELLOW



OD GREEN



PRESS AND PULL LATCHES

These smooth-opening, patented latches hold tight under pressure and impact with easy-opening performance. Tested to over 400 lbs., yet open with a simple release button.



MOLDED-IN LOCKABLE HASPS

Twin mating hasp holes on the rim of the case allow padlocks like Pelican's TSA approved cable padlock to keep your gear in and thieves out.



VORTEX® PRESSURE RELEASE VALVE

The automatic pressure release valve prevents vacuum lock, making it easy to open your case, even after extreme altitude changes. The microscopic filter blocks water molecules and dust particles so your gear stays clean.



RUGGED IN-LINE WHEELS

Shielded from dust, dirt and other contaminants – ball bearing wheels provide low-friction, low-drag rolling for easy movement of heavy loads.

*Select models only.



DOUBLE-LAYER, SOFT-GRIP HANDLES

When the weather goes south you'll find a secure grip that won't slip. An in-tool vulcanizing process over-molds the grips to the polymer handle for a lifetime of dependable performance.

SMALL CASES

Perfect for small gear and instruments, with all the features found in our larger cases: strong HPX™ resin construction, Vortex™ valve, and Press and Pull latches.



iM2050

INTERNAL DIMS:
9.50" x 7.50" x 4.25"
(24.1 x 19.1 x 10.8 cm)

EXTERNAL DIMS:
11.80" x 9.80" x 4.70"
(30 x 24.9 x 11.9 cm)



Cat. No. **iM2050** **WF**
Cat. No. **iM2050-X0000** **NF**
Cat. No. **iM2050-X0002** **WD**



iM2075

INTERNAL DIMS:
9.50" x 7.50" x 7.25"
(24.1 x 19.1 x 18.4 cm)

EXTERNAL DIMS:
11.80" x 9.80" x 7.70"
(30 x 24.9 x 19.6 cm)



Cat. No. **iM2075** **WF**
Cat. No. **iM2075-X0000** **NF**
Cat. No. **iM2075-X0002** **WD**



iM2100

INTERNAL DIMS:
13.00" x 9.20" x 6.00"
(33 x 23.4 x 15.2 cm)

EXTERNAL DIMS:
14.20" x 11.40" x 6.50"
(36.1 x 29 x 16.5 cm)



Cat. No. **iM2100** **WF**
Cat. No. **iM2100-X0000** **NF**
Cat. No. **iM2100-X0002** **WD**



MEDIUM CASES

From firefighters, EMTs, outdoor enthusiasts, and law enforcement to industrial engineers and photographers, there's a Pelican™ Storm Case™ for every professional. Built strong in four standard configurations: *TrekPak™ dividers, Pick N Pluck™ foam, *padded dividers, or empty. *Select models only.

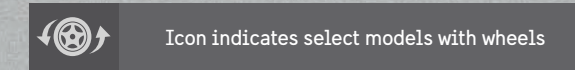

iM2200

INTERNAL DIMS:
15.00" x 10.50" x 6.00"
(38.1 x 26.7 x 15.2 cm)

EXTERNAL DIMS:
16.20" x 12.70" x 6.60"
(41.1 x 32.3 x 16.8cm)



Cat. No. **iM2200** **WF**
Cat. No. **iM2200-X0000** **NF**
Cat. No. **iM2200-X0002** **WD**



iM2300

INTERNAL DIMS:
17.00" x 11.70" x 6.20"
(43.2 x 29.7 x 15.7cm)

EXTERNAL DIMS:
18.20" x 13.9" x 6.70"
(46.2 x 35.3 x 17cm)



Cat. No. **iM2300** **WF**
Cat. No. **iM2300-X0000** **NF**
Cat. No. **iM2300-X0002** **WD**



iM2275

INTERNAL DIMS:
14.12" x 13.19" x 9.90"
(35.9 x 33.5 x 25.1 cm)

EXTERNAL DIMS:
15.25" x 15.50" x 10.22"
(38.7 x 39.4 x 26 cm)



Cat. No. **iM2275** **WF**
Cat. No. **iM2275-X0000** **NF**
Cat. No. **iM2275-X0002** **WD**
Cat. No. **iM2275-X0006** **TP**



iM2306

INTERNAL DIMS:
17.00" x 6.30" x 6.20"
(43.2 x 16 x 15.7cm)

EXTERNAL DIMS:
18.20" x 8.40" x 6.70"
(46.2 x 21.3 x 17cm)



Cat. No. **iM2306** **WF**
Cat. No. **iM2306-X0000** **NF**
Cat. No. **iM2306-X0002** **WD**



iM2370 LAPTOP CASE

INTERNAL DIMS:
18.20" x 12.10" x 5.20"
(46.2 x 30.7 x 13.2 cm)

EXTERNAL DIMS:
20.00" x 14.70" x 5.80"
(50.8 x 37.3 x 14.7 cm)



Cat. No. **iM2370** **WF**
Cat. No. **iM2370-X0000** **NF**
Cat. No. **iM2370-X0002** **WD**
Cat. No. **iM2370-X0003** (Computer Case Deluxe)



iM2400

INTERNAL DIMS:
18.00" x 13.00" x 6.70"
(45.7 x 33 x 17 cm)

EXTERNAL DIMS:
19.20" x 15.20" x 7.30"
(48.8 x 38.6 x 18.5 cm)



Cat. No. **iM2400** WF
Cat. No. **iM2400-X0000** NF
Cat. No. **iM2400-X0002** WD



iM2435



INTERNAL DIMS:
17.50" x 6.50" x 15.50"
(44.5 x 16.5 x 39.4 cm)

EXTERNAL DIMS:
18.63" x 9.25" x 16.50"
(47.3 x 23.5 x 41.9 cm)



Cat. No. **iM2435** WF
Cat. No. **iM2435-X0000** NF
Cat. No. **iM2435-X0002** WD
(includes lid organizer)



iM2450

INTERNAL DIMS:
18.00" x 13.00" x 8.40"
(45.7 x 33 x 21.3 cm)

EXTERNAL DIMS:
19.20" x 15.20" x 9.00"
(48.8 x 38.6 x 22.9 cm)



Cat. No. **iM2450** WF
Cat. No. **iM2450-X0000** NF
Cat. No. **iM2450-X0002** WD



iM2500



INTERNAL DIMS:
20.50" x 11.50" x 7.20"
(52.1 x 29.2 x 18.3 cm)

EXTERNAL DIMS:
21.70" x 14.10" x 8.90"
(55.1 x 35.8 x 22.6 cm)



Cat. No. **iM2500** WF
Cat. No. **iM2500-X0000** NF
Cat. No. **iM2500-X0002** WD
Cat. No. **iM2500-00006** TP



iM2600

INTERNAL DIMS:
20.00" x 14.00" x 7.70"
(50.8 x 35.6 x 19.6 cm)

EXTERNAL DIMS:
21.20" x 16.00" x 8.30"
(53.8 x 40.6 x 21.1 cm)



Cat. No. **iM2600** WF
Cat. No. **iM2600-X0000** NF
Cat. No. **iM2600-X0002** WD



iM2620



INTERNAL DIMS:
20.00" x 14.00" x 10.00"
(50.8 x 35.6 x 25.4 cm)

EXTERNAL DIMS:
21.20" x 16.00" x 10.60"
(53.8 x 40.6 x 26.9 cm)



Cat. No. **iM2620** WF
Cat. No. **iM2620-X0000** NF
Cat. No. **iM2620-X0002** WD
Cat. No. **iM2620-00006** TP



LARGE CASES

In the lab or out in the field, a large Pelican™ Storm Case™ with HPX™ resin construction stores and protects valuable and sensitive equipment from the elements. Pick N Pluck™ foam adds extra protection from shock during transport.



Icon indicates select models with wheels

iM2700

INTERNAL DIMS:
22.00" x 17.00" x 8.00"
(55.9 x 43.2 x 20.3 cm)

EXTERNAL DIMS:
24.60" x 19.70" x 8.60"
(62.5 x 50 x 21.8 cm)



Cat. No. **iM2700** WF
Cat. No. **iM2700-X0000** NF
Cat. No. **iM2700-X0002** WD



iM2720



INTERNAL DIMS:
22.00" x 17.00" x 10.00"
(55.9 x 43.2 x 25.4 cm)

EXTERNAL DIMS:
24.60" x 19.70" x 11.70"
(62.5 x 50 x 29.7 cm)



Cat. No. **iM2720** WF
Cat. No. **iM2720-X0000** NF
Cat. No. **iM2720-X0002** WD
Cat. No. **iM2720-00006** TP



iM2750



INTERNAL DIMS:
22.00" x 17.00" x 12.70"
(55.9 x 43.2 x 32.2 cm)

EXTERNAL DIMS:
24.60" x 19.70" x 14.40"
(62.5 x 50 x 36.6 cm)



Cat. No. **iM2750** WF
Cat. No. **iM2750-X0000** NF
Cat. No. **iM2750-X0002** WD



iM2875



INTERNAL DIMS:
22.50" x 21.10" x 11.40"
(57.2 x 53.6 x 29 cm)

EXTERNAL DIMS:
24.90" x 23.70" x 13.10"
(63.2 x 60.2 x 33.3 cm)



Cat. No. **iM2870** WF
Cat. No. **iM2870-X0000** NF
Cat. No. **iM2870-X0002** WD



iM2950



INTERNAL DIMS:
29.00" x 18.00" x 10.50"
(73.7 x 45.7 x 26.7 cm)

EXTERNAL DIMS:
31.30" x 20.40" x 12.20"
(79.5 x 51.8 x 31 cm)



Cat. No. **iM2950** WF
Cat. No. **iM2950-X0000** NF
Cat. No. **iM2950-X0002** WD
Cat. No. **iM2950-00006** TP



iM2975



INTERNAL DIMS:
29.00" x 18.00" x 13.80"
(73.7 x 45.7 x 35.1 cm)

EXTERNAL DIMS:
31.30" x 20.40" x 15.50"
(79.5 x 51.8 x 39.4 cm)



■ ■
Cat. No. **iM2975** **WF**
Cat. No. **iM2975-X0000** **NF**
Cat. No. **iM2975-X0002** **WD**

iM3075



INTERNAL DIMS:
29.80" x 20.80" x 17.80"
(75.7 x 52.8 x 45.2 cm)

EXTERNAL DIMS:
33.30" x 24.40" x 19.30"
(84.6 x 62 x 49 cm)



■ ■
Cat. No. **iM3075** **WF**
Cat. No. **iM3075-X0000** **NF**
Cat. No. **iM3075-X0002** **WD**

iM3100



INTERNAL DIMS:
36.50" x 14.00" x 6.00"
(92.7 x 35.6 x 15.2 cm)

EXTERNAL DIMS:
39.80" x 16.50" x 6.70"
(101.1 x 41.9 x 17 cm)



■ ■
Cat. No. **iM3100** **WF**
Cat. No. **iM3100-X0000** **NF**

iM3200



INTERNAL DIMS:
44.00" x 14.00" x 6.00"
(111.8 x 35.6 x 15.2 cm)

EXTERNAL DIMS:
47.20" x 16.50" x 6.70"
(119.9 x 41.9 x 17 cm)



■ ■
Cat. No. **iM3200** **WF**
Cat. No. **iM3200-X0000** **NF**

iM3220



INTERNAL DIMS:
44.00" x 14.00" x 8.50"
(111.8 x 35.6 x 21.6 cm)

EXTERNAL DIMS:
47.20" x 16.50" x 9.20"
(119.9 x 41.9 x 23.4 cm)

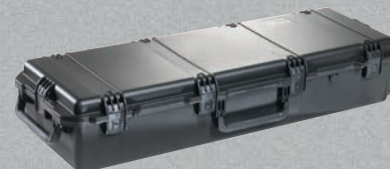

■ ■
Cat. No. **iM3220** **WF**
Cat. No. **iM3220-X0000** **NF**

iM3300



INTERNAL DIMS:
50.50" x 14.00" x 6.00"
(128.3 x 35.6 x 15.2 cm)

EXTERNAL DIMS:
53.80" x 16.50" x 6.70"
(136.7 x 41.9 x 17 cm)



■ ■
Cat. No. **iM3300** **WF**
Cat. No. **iM3300-X0000** **NF**

iM3300RFL



INTERNAL DIMS:
50.50" x 14.00" x 6.00"
(128.3 x 35.6 x 15.2 cm)

EXTERNAL DIMS:
53.80" x 16.50" x 6.70"
(136.7 x 41.9 x 17 cm)



■ ■
Cat. No. **iM3300RFL** **WF**

iM3300SGN



INTERNAL DIMS:
50.50" x 14.00" x 6.00"
(128.3 x 35.6 x 15.2 cm)

EXTERNAL DIMS:
53.80" x 16.50" x 6.70"
(136.7 x 41.9 x 17 cm)



■ ■
Cat. No. **iM3300SGN** **WF**

iM3410



INTERNAL DIMS:
54.50" x 10.00" x 6.00"
(138.4 x 25.4 x 15.2 cm)

EXTERNAL DIMS:
57.74" x 12.71" x 6.67"
(146.7 x 32.3 x 16.9 cm)



■ ■
Cat. No. **iM3410** **WF**
Cat. No. **iM3410-X0000** **NF**



S = Standard feature
O = Optional accessory

S = Standard feature
O = Optional accessory

PELICAN™ CASE SERIES | CASE SPECIFICATIONS & FEATURES



Main specifications table for Pelican cases, columns include: CAT. NO., INTERIOR DIMENSIONS (inches, centimeters), EXTERIOR DIMENSIONS (inches, centimeters), AIR CASES, PUC CASES, MICRO CASE SERIES™, SMALL CASES, DIGITAL SURVIVAL CASES, and COLORS.

PELICAN™ CASE SERIES | CASE SPECIFICATIONS & FEATURES

Main specifications table for Pelican cases, columns include: CAT. NO., INTERIOR DIMENSIONS (inches, centimeters), EXTERIOR DIMENSIONS (inches, centimeters), MEDIUM CASES, LARGE CASES, LONG CASES, PELICAN™ STORM CASE™ SERIES, and COLORS.

CASE INTERIOR SIZE COMPARISON

Interior size comparison chart features the smallest case size [top] to largest case size [bottom], based on interior volume size.

 PELICAN™ PROTECTOR CASE™
  PELICAN™ AIR CASE
  PELICAN™ STORM CASE™

CAT. NO.	INTERIOR DIMENSIONS		WEIGHT	
	inches	centimeters	lbs	kg
1120 PROTECTOR	7.29" x 4.78" x 3.33"	(18.5 x 12.1 x 8.5)	1.34	0.608
1150 PROTECTOR	8.29" x 5.79" x 3.75"	(21.1 x 14.7 x 9.5)	1.61	0.730
1170 PROTECTOR	10.54" x 6.04" x 3.16"	(26.8 x 15.3 x 8)	1.96	0.889
1200 PROTECTOR	9.25" x 7.12" x 4.12"	(23.5 x 18.1 x 10.5)	2.65	1.202
iM2050 STORM	9.5" x 7.5" x 4.25"	(24.1 x 19.1 x 10.8)	2.7	1.225
1300 PROTECTOR	9.17" x 7" x 6.12"	(23.3 x 17.8 x 15.5)	3.09	1.402
iM2075 STORM	9.5" x 7.5" x 7.25"	(24.1 x 19.1 x 18.4)	3.3	1.497
1400 PROTECTOR	11.81" x 8.87" x 5.18"	(30 x 22.5 x 13.2)	3.97	1.801
1470 PROTECTOR	15.7" x 10.7" x 3.87"	(39.9 x 27.2 x 9.8)	4.28	1.941
iM2306 STORM	17" x 6.3" x 6.2"	(43.2 x 16 x 15.7)	4.3	1.950
iM2100 STORM	13" x 9.2" x 6"	(33 x 23.4 x 15.2)	4.2	1.905
1490 PROTECTOR	17.75" x 11.37" x 4.12"	(45.1 x 28.9 x 10.5)	5.47	2.481
1450 PROTECTOR	14.66" x 10.24" x 6.12"	(37.2 x 26 x 15.5)	5.51	2.499
1495 PROTECTOR	18.87" x 13.12" x 3.81"	(47.9 x 33.3 x 9.7)	7.23	3.279
iM2200 STORM	15" x 10.5" x 6"	(38.1 x 26.7 x 15.2)	4.9	2.223
1485 AIR	17.75" x 10.18" x 6.15"	(45.1 x 25.9 x 15.6)	4.57	2.073
iM2370 STORM	18.2" x 12.1" x 5.2"	(46.2 x 30.7 x 13.2)	5.7	2.585
1500 PROTECTOR	16.75" x 11.18" x 6.12"	(42.5 x 28.4 x 15.5)	7.13	3.234
iM2300 STORM	17" x 11.7" x 6.2"	(43.2 x 29.7 x 15.7)	5.9	2.676
1507 AIR	15.15" x 11.38" x 8.52"	(38.5 x 28.9 x 21.6)	5.24	2.377
1520 PROTECTOR	18.06" x 12.89" x 6.72"	(45.9 x 32.7 x 17.1)	8.29	3.760
1525 AIR	20.5" x 11.31" x 6.75"	(52.1 x 28.7 x 17.1)	5.99	2.717
iM2400 STORM	18" x 13" x 6.7"	(45.7 x 33 x 17)	6.5	2.948
1535 AIR	20.39" x 11.2" x 7.21"	(51.8 x 28.4 x 18.3)	8.69	3.942
1510 PROTECTOR	19.75" x 11" x 7.6"	(50.2 x 27.9 x 19.3)	11.99	5.439
iM2500 STORM	20.5" x 11.5" x 7.2"	(52.1 x 29.2 x 18.3)	11.1	5.035
iM2435 STORM	17.5" x 6.5" x 15.5"	(44.5 x 16.5 x 39.4)	10	4.536
iM2275 STORM	14.12" x 13.19" x 9.9"	(35.9 x 33.5 x 25.1)	8	3.629
iM2450 STORM	18" x 13" x 8.4"	(45.7 x 33 x 21.3)	7.4	3.357
1460 PROTECTOR	18.54" x 9.92" x 10.92"	(47.1 x 25.2 x 27.7)	8.75	3.969
1466 AIR	18.62" x 9.99" x 10.93"	(47.3 x 25.4 x 27.8)	7.12	3.230
1550 PROTECTOR	18.63" x 14.18" x 7.72"	(47.3 x 36 x 19.6)	10.58	4.799
iM2600 STORM	20" x 14" x 7.7"	(50.8 x 35.6 x 19.6)	8.5	3.856
1557 AIR	17.33" x 13" x 9.75"	(44 x 33 x 24.8)	6.6	2.994
1556 AIR	23" x 12.75" x 7.5"	(58.4 x 32.4 x 19.1)	7.37	3.343
1700 PROTECTOR	35.75" x 13.5" x 5.25"	(90.8 x 34.3 x 13.3)	16.09	7.298

CAT. NO.	INTERIOR DIMENSIONS		WEIGHT	
	inches	centimeters	lbs	kg
1560 PROTECTOR	19.92" x 14.98" x 9"	(50.6 x 38 x 22.9)	17	7.711
0340 PROTECTOR	18" x 18" x 18"	(45.7 x 45.7 x 45.7)	24	10.886
iM2620 STORM	20" x 14" x 10"	(50.8 x 35.6 x 25.4)	12.5	5.670
1600 PROTECTOR	21.51" x 16.54" x 7.99"	(54.6 x 42 x 20.3)	13	5.897
0450 PROTECTOR	20.56" x 10.97" x 12.65"	(52.2 x 27.9 x 32.1)	41.50	18.8
1720 PROTECTOR	42" x 13.5" x 5.25"	(106.7 x 34.3 x 13.3)	16.76	7.602
iM2700 STORM	22" x 17" x 8"	(55.9 x 43.2 x 20.3)	11.1	5.035
1605 AIR	26" x 14" x 8.38"	(66 x 35.6 x 21.3)	9.28	4.209
iM3100 STORM	36.5" x 14" x 6"	(92.7 x 35.6 x 15.2)	15.2	6.895
iM3410 STORM	54.5" x 10" x 6"	(138.4 x 25.4 x 15.2)	18	8.165
1750 PROTECTOR	50.5" x 13.5" x 5.25"	(128.3 x 34.3 x 13.3)	23.59	10.700
iM3200 STORM	44" x 14" x 6"	(111.8 x 35.6 x 15.2)	17.7	8.029
iM2720 STORM	22" x 17" x 10"	(55.9 x 43.2 x 25.4)	16.8	7.620
1610 PROTECTOR	21.78" x 16.69" x 10.62"	(55.3 x 42.4 x 27)	19.5	8.845
1607 AIR	21.05" x 15.81" x 11.63"	(53.5 x 40.2 x 29.5)	13.2	5.987
iM3300 STORM	50.5" x 14" x 6"	(128.3 x 35.6 x 15.2)	19.1	8.664
1670 PROTECTOR	28.1" x 16.49" x 9.19"	(71.4 x 41.9 x 23.3)	23	10.433
1615 AIR	29.59" x 15.5" x 9.38"	(75.2 x 39.4 x 23.8)	14.06	6.378
1620 PROTECTOR	21.48" x 16.42" x 12.54"	(54.6 x 41.7 x 31.9)	21.20	9.6
iM2750 STORM	22" x 17" x 12.7"	(55.9 x 43.2 x 32.3)	18.5	8.391
iM3220 STORM	44" x 14" x 8.5"	(111.8 x 35.6 x 21.6)	20.4	9.253
1650 PROTECTOR	28.57" x 17.52" x 10.65"	(72.6 x 44.5 x 27.1)	24.03	10.900
iM2875 STORM	22.5" x 21.1" x 11.4"	(57.2 x 53.6 x 29)	20.1	9.117
1637 AIR	23.43" x 17.55" x 13.25"	(59.5 x 44.6 x 33.7)	15.2	6.895
iM2950 STORM	29" x 18" x 10.5"	(73.7 x 45.7 x 26.7)	20.8	9.435
0340 PROTECTOR	18.00" x 18.00" x 18.00"	(45.7 x 45.7 x 45.7)	24	10.9
1745 AIR	44" x 16.77" x 8"	(111.8 x 42.6 x 20.3)	17.26	7.829
1740 PROTECTOR	40.98" x 12.92" x 12.13"	(104.1 x 32.8 x 30.8)	22	9.979
iM2975 STORM	29" x 18" x 13.8"	(73.7 x 45.7 x 35.1)	22.8	10.342
1770 PROTECTOR	54.58" x 15.58" x 8.63"	(138.6 x 39.6 x 21.9)	29	13.154
1640 PROTECTOR	23.7" x 24" x 13.9"	(60.2 x 61 x 35.3)	34	15.422
0350 PROTECTOR	20" x 20" x 20"	(50.8 x 50.8 x 50.8)	25.99	11.789
1630 PROTECTOR	27.7" x 20.98" x 15.5"	(70.4 x 53.3 x 39.4)	31	14.061
1660 PROTECTOR	28.2" x 19.66" x 17.63"	(71.6 x 49.9 x 44.8)	34.16	15.495
1730 PROTECTOR	34" x 24" x 12.5"	(86.4 x 61 x 31.8)	30	13.608
iM3075 STORM	29.8" x 20.8" x 17.8"	(75.7 x 52.8 x 45.2)	31.5	14.288
1690 PROTECTOR	30.13" x 25.13" x 15.36"	(76.5 x 63.8 x 39)	34	15.422
1780 PROTECTOR	41.12" x 21.54" x 14.88"	(104.4 x 54.7 x 37.8)	38.4	17.418
0370 PROTECTOR	24" x 24" x 24"	(61 x 61 x 61)	31.97	14.501
0500 PROTECTOR	34.95" x 18.45" x 25.25"	(88.8 x 46.9 x 64.1)	50	22.680
0550 PROTECTOR	47.57" x 24.07" x 17.68"	(120.8 x 61.1 x 44.9)	79.2	35.925



SERVICES & ACCESSORIES



SHOULDER STRAP

Heavy-duty shoulder strap offers comfort and support.

THINK INSIDE AND OUTSIDE THE BOX

The exterior protection of your hard case is only half the story and, with interior customization and accessory options, you get 360° of protection and organization solutions.

Inside the Box interior case solutions offer you multiple organization options. Choose from our TrekPak™ divider system, padded dividers, or Pick N Pluck™ foam for the organization your equipment deserves.

Custom case solutions make protecting complex equipment easy. With options like custom engineered deck mount suspension systems and specialized foam options, your equipment stays organized and protected from extreme G-forces.

Pelican also offers a wide range of accessories including custom nameplates, caster wheels, shoulder straps, and TSA locks, making it easier to travel with and transport your gear without concern.

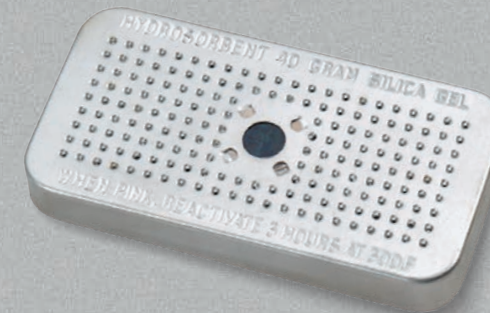

PELI DESICCANT (SILICA GEL)

Absorbs moisture and prevents condensation from forming inside a case in high-humidity climates.



TSA LOCKS

TSA-accepted locks keep thieves out, while allowing TSA necessary access.



CARD HOLDER

Removeable card holders are ideal for shipping documents and identification cards.



LID ORGANIZER

Zippered mesh pockets keep your smaller equipment organized.



NAMEPLATES

Custom order nameplates to make it easier to identify your case.



PALLET RISERS

Pallet risers raise the level of a case to allow forklift forks to slide under.



CASTER WHEEL KITS

Detachable caster wheels can be attached for easier transport and detached for storage.



LID STAYS

Lid stays lock your lid in place to allow access to your equipment without the worry of accidental lid closure.

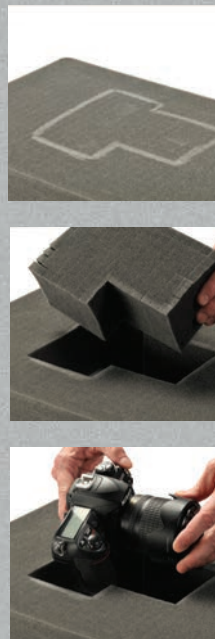

PICK N PLUCK™ FOAM

An easy, do-it-yourself system for the interior of the case. Layers of foam are pre-scored in 1/2" or 1" cubes. Simply lay your equipment on the foam, tape or chalk to mark the foam, and pluck away. Always allow at least one inch of foam between your equipment and the wall of the case.

We offer replacement foam sets online at pelican.com. Just enter the case catalog number in the search field to view available foam sets.

Solid foam (which can be cut with an electric knife or coping saw) is preferred for oversize items such as long guns. The following cases ship with solid foam instead of Pick N Pluck™ Foam: 1700, 1720, 1740, 1750, 1770, iM3100, iM3200, iM3220, iM3300, iM3410



TREKPAK™ DIVIDER & PICK N PLUCK™ FOAM HYBRID INTERIOR

With two NEW Pelican™ Hybrid interiors, organization has been taken to the next level. TrekPak™ dividers and Pick N Pluck™ foam have been combined in two of our most popular cases, the Pelican™ 1510 Protector Case™ and the Pelican™ 1535 Air case. This combination allows for unlimited options to keep your equipment intact, organized and ready to go.

Pick N Pluck™ foam is perfect for fixed solutions and TrekPak™ dividers give you the freedom to adjust the case to your ever-changing accessory needs.

Hybrid configuration available for 1510 (Cat No.1510TPF) and 1535 Air (Cat No.1535TPF)



TREKPAK™ DIVIDER SYSTEM

Now available in our most popular case sizes, our TrekPak™ Divider System is a versatile kit that allows you to organize your case like a pro. Durable, closed-cell foam is laminated to corrugated panels that provide a precise grid of protection without wasting any space.

The TrekPak™ Divider System comes complete with perimeter wall sections installed, divider panels, locking pins and a fool-proof cutting tool. Extra divider material is included and available separately so you can reconfigure your case anytime.



Available in our most popular Pelican™ Protector Case™, Pelican™ Storm Case™, and Pelican™ Air Case sizes. TrekPak™ Divider System also sold separately.



PADDED DIVIDERS

A classic organizational solution. Versatile and durable, padded dividers easily adjust to fit your equipment into any configuration on the fly. Plus, you can quickly identify your gear with the padded divider's high contrast color.

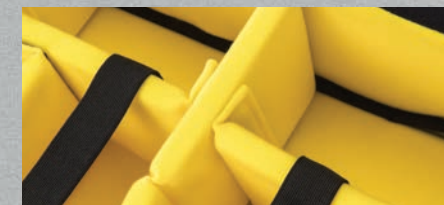

Padded Divider Walls are covered with mountable fabric, providing endless reconfigurations



- O-ring
- Panel Frame/Bezel Kit
- Attachment Hardware

PANEL FRAME AND BEZEL KITS

Many Pelican™ cases can be adapted for use with electronic interface panels by using a Panel Frame (Pelican™ Protector Case™) or Bezel Kit (Pelican™ Storm Case™) accessory. Mount most interface panels (customer supplied) flush with the rim of the Pelican™ Protector Case™ or desired area in a Pelican™ Storm Case™, and your technology is ready to go.

A polymer o-ring seals the panel so the base of the case remains watertight, even with the lid open. The mounting bracket, fasteners and o-ring are included in the Panel Frame Kit.

PELICAN™ PROTECTOR CASE™ WITH PANEL FRAME AVAILABILITY				
CAT. NO.	INTERIOR DIMENSIONS		EXTERIOR DIMENSIONS	
	inches/cm	LxWxH	inches/cm	LxWxH
1120	7.29" x 4.78" x 3.33" (18.5 x 12.1 x 8.5 cm)		8.41" x 6.76" x 3.87" (21.4 x 17.2 x 9.8 cm)	
1150	8.29" x 5.79" x 3.75" (21.1 x 14.7 x 9.5 cm)		9.44" x 7.80" x 4.29" (24 x 19.8 x 10.9 cm)	
1200	9.25" x 7.12" x 4.12" (23.5 x 18.1 x 10.5 cm)		10.62" x 9.68" x 4.87" (27 x 24.6 x 12.4 cm)	
1300	9.17" x 7.00" x 6.12" (23.3 x 17.8 x 15.5 cm)		10.62" x 9.68" x 6.87" (27 x 24.6 x 17.4 cm)	
1400	11.81" x 8.87" x 5.18" (30 x 22.5 x 13.2 cm)		13.37" x 11.62" x 6.00" (34 x 29.5 x 15.2 cm)w	
1430	13.56" x 5.76" x 11.70" (34.4 x 14.6 x 29.7 cm)		16.40" x 8.71" x 13.15" (41.7 x 22.1 x 33.4 cm)	
1450	14.66" x 10.24" x 6.12" (37.2 x 26 x 15.5 cm)		16.44" x 13" x 6.82" (41.8 x 33 x 17.3 cm)	
1470	15.70" x 10.70" x 3.87" (39.9 x 27.2 x 9.8 cm)		16.88" x 13.23" x 4.47" (42.9 x 33.6 x 11.4 cm)	
1490	17.75" x 11.37" x 4.12" (45.1 x 28.9 x 10.5 cm)		19.87" x 13.93" x 4.68" (50.5 x 35.4 x 11.9 cm)	
1500	16.75" x 11.18" x 6.12" (42.5 x 28.4 x 15.5 cm)		18.50" x 14.06" x 6.93" (47 x 35.7 x 17.6 cm)	
1520	18.06" x 12.89" x 6.72" (45.9 x 32.7 x 17.1 cm)		19.78" x 15.77" x 7.41" (50.2 x 40.1 x 18.8 cm)	
1550	18.63" x 14.18" x 7.72" (47.3 x 36 x 19.6 cm)		20.66" x 17.20" x 8.40" (52.5 x 43.7 x 21.3 cm)	

⚠ WARNING: This product can expose you to chemicals including Lead and lead compounds, which are known to the State of California to cause cancer and birth defects or other reproductive harm. For more information go to www.P65Warnings.ca.gov.

PELICAN™ STORM CASE™ WITH BEZEL KIT AVAILABILITY				
CAT. NO.	INTERIOR DIMENSIONS		EXTERIOR DIMENSIONS	
	inches/cm	LxWxH	inches/cm	LxWxH
iM2050	9.5" x 7.5" x 4.25" (24.1 x 19.1 x 10.8 cm)		11.8" x 9.8" x 4.7" (30 x 24.9 x 11.9 cm)	
iM2075	9.5" x 7.5" x 7.25" (24.1 x 19.1 x 18.4 cm)		11.8" x 9.8" x 7.7" (30 x 24.9 x 19.6 cm)	
iM2100	13" x 9.2" x 6" (33 x 23.4 x 15.2 cm)		14.2" x 11.4" x 6.5" (36.1 x 29 x 16.5 cm)	
iM2200	15" x 10.5" x 6" (38.1 x 26.7 x 15.2 cm)		16.2" x 12.7" x 6.6" (41.1 x 32.3 x 16.8 cm)	
iM2300	17" x 11.7" x 6.2" (43.2 x 29.7 x 15.7 cm)		18.2" x 13.9" x 6.7" (46.2 x 35.3 x 17 cm)	
iM2306	17" x 6.3" x 6.2" (43.2 x 16 x 15.7 cm)		18.2" x 8.4" x 6.7" (46.2 x 21.3 x 17 cm)	
iM2370	18.2" x 12.1" x 5.2" (46.2 x 30.7 x 13.2 cm)		20" x 14.7" x 5.8" (50.8 x 37.3 x 14.7 cm)	
iM2400	18" x 13" x 6.7" (45.7 x 33 x 17 cm)		19.2" x 15.2" x 7.3" (48.8 x 38.6 x 18.5 cm)	
iM2450	18" x 13" x 8.4" (45.7 x 33 x 21.3 cm)		19.2" x 15.2" x 9" (48.8 x 38.6 x 22.9 cm)	
iM2500	20.5" x 11.5" x 7.2" (52.1 x 29.2 x 18.3 cm)		21.7" x 14.1" x 8.9" (55.1 x 35.8 x 22.6 cm)	
iM2600	20" x 14" x 7.7" (50.8 x 35.6 x 19.6 cm)		21.2" x 16" x 8.3" (53.8 x 40.6 x 21.1 cm)	
iM2620	20" x 14" x 10" (50.8 x 35.6 x 25.4 cm)		21.2" x 16" x 10.6" (53.8 x 40.6 x 26.9 cm)	
iM2700	22" x 17" x 8" (55.9 x 43.2 x 20.3 cm)		24.6" x 19.7" x 8.6" (62.5 x 50 x 21.8 cm)	
iM2720	22" x 17" x 10" (55.9 x 43.2 x 25.4 cm)		24.6" x 19.7" x 11.7" (62.5 x 50 x 29.7 cm)	
iM2750	22" x 17" x 12.7" (55.9 x 43.2 x 32.2 cm)		24.6" x 19.7" x 14.4" (62.5 x 50 x 36.6 cm)	
iM2875	22.5" x 21.1" x 11.4" (57.2 x 53.6 x 29 cm)		24.9" x 23.7" x 13.1" (63.2 x 60.2 x 33.3 cm)	
iM2950	29" x 18" x 10.5" (73.7 x 45.7 x 26.7 cm)		31.3" x 20.4" x 12.2" (79.5 x 51.8 x 31 cm)	
iM2975	29" x 18" x 13.8" (73.7 x 45.7 x 35.1 cm)		31.3" x 20.4" x 15.5" (79.5 x 51.8 x 39.4 cm)	



LID ORGANIZERS

Made of simulated leather or ballistic nylon with nylon zippers. A wide variety of pocket sizes protect and keep your gear organized. They install easily with Velcro® strips (included).



PELI™ QUICK MOUNTS

An alternative to panel frames, Peli™ Quick Mounts attach to the inside case wall using special adhesives. The interface panel can then be mounted on top of the Peli™ Quick Mounts and secured with screws (for Pelican™ Protector Case™ models only).



CUSTOM LOGO SERVICES

Personalize the outside of the case with your company logo or have your name engraved on the nameplate (Pelican™ Protector Case™). Logos can be applied in multiple colors as a Mylar® decal (250 piece minimum) or as a vibrant fade-resistant, scratch-resistant hot-stamped ink.

ELECTRONIC INSTALLATIONS

Many Pelican™ Protector Case™ and Pelican™ Storm Case™ models allow customization for electronics. Injection molding provides a reliable, durable, ready-to-ship enclosure with consistent dimensions. The copolymer material can be machined, drilled and sanded smooth.

These properties make the Pelican™ Protector Case™ and Pelican™ Storm Case™ suitable

for use with bulkhead connectors. Attaching equipment to the interior is equally simple using common hardware such as bolts and rivets. The hardware can be made watertight by use of o-rings, rubber gaskets or silicone.

Mounting the entire case to a wall or post is a simple way to create a waterproof control box for field use.

For prices and further information, please call Pelican Customer Service at 310.326.4700 or toll free at 800.473.5422.

CUSTOM CASE SOLUTIONS

www.pelican.com/custom

While every Pelican™ case is built tough on the outside, we provide custom services to protect delicate items on the inside. Custom foam and extreme solutions such as deck mount suspension systems and

certified laboratory testing will keep your equipment organized, intact and protected through the most volatile conditions.

LOW COMPLEXITY Custom Foam Solutions



MEDIUM COMPLEXITY Interior/Exterior Solutions



EXTREME COMPLEXITY Interior/Exterior Solutions with Testing Requirements

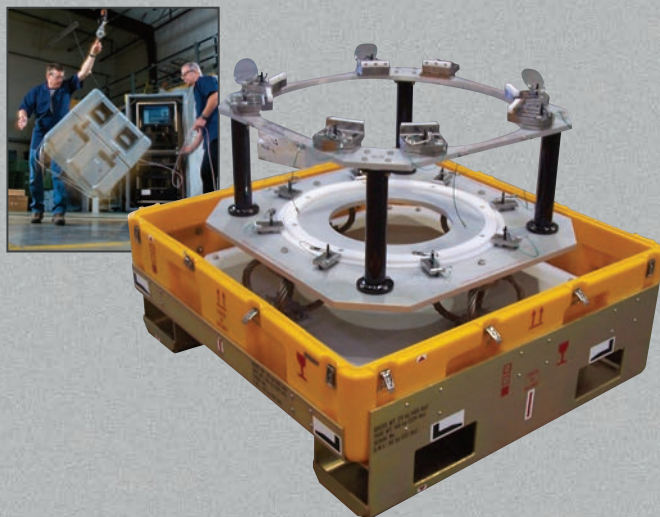

EXAMPLES

- Custom Labels
- Humidity Indicators
- Customizable cushions, such as Polyethylene and Polyurethane, in multiple densities, as well as other specialty foams

EXAMPLES

- Shock Mount Metal Decks
- Custom Metal Work
- Cut and Weld
- Custom Bezel Solutions
- Forklift Risers

EXAMPLES

- Shock Testing
- Vibration Testing
- Drop Testing
- Salt/Fog Testing
- Pressure Testing

CUSTOM FOAM MADE SPECIFICALLY FOR YOUR EQUIPMENT

Pelican Products provides expert packaging solutions for both of our case lines, and we work with partners who have been in the packaging industry for over 50 years. Save time and cost by purchasing a fast and complete turnkey solution from Pelican.

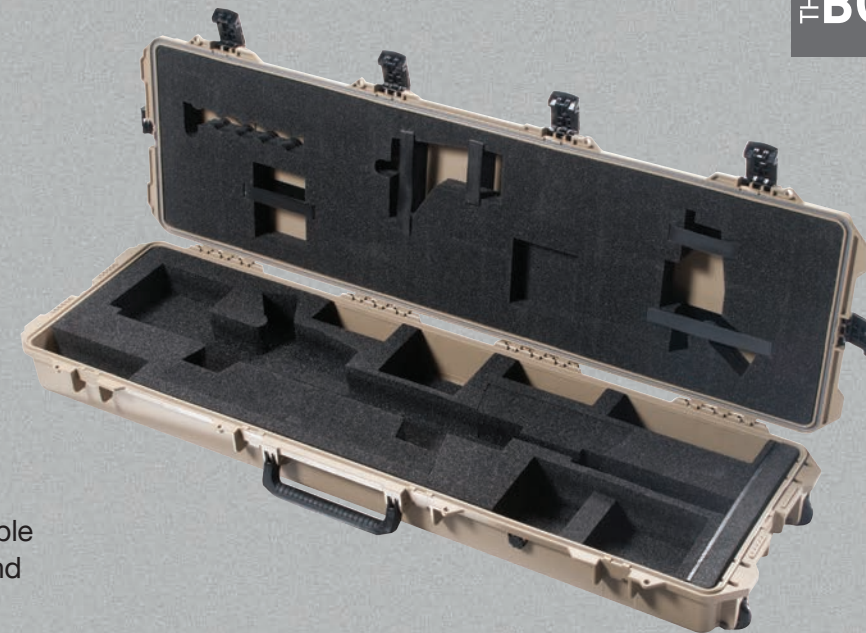

Our Pelican Case Centers have the most advanced foam cutting tools, and our engineers have the latest software applications so they are able to create a design that is precise and determines the most cost effective method of manufacture.

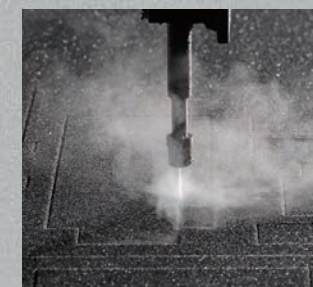

Water Jet Technology



Die Cut Technology



CNC Router Technology

PELICAN ENGINEERS TAKE EVERYTHING INTO CONSIDERATION WHEN DESIGNING YOUR CUSTOM CUSHION:

- Unit Dimensions
- Accessories and Other Items
- Fragility
- Military Specifications
- UV Resistance
- Commercial Spec
- Anti Static Grounding
- Weight and Weight Distribution
- Size Restrictions
- Shipping Method and Frequency (ground, air or "around the town")
- Option Requirements
- ...and more

All of this information allows us to choose the right Pelican™ case and foam type for your application.

NOT ALL FOAM IS EQUAL

With over 50 years of professional packaging experience, Pelican engineers utilize sophisticated engineering technology to provide a foam solution that not only serves to protect, but also creates a professional presentation that you will be proud to display.

From simple to very complex cushion designs, we know how to provide protection that will get your gear or mission critical items safely to their destination.



CUSHIONING MATERIAL

POLYURETHANE:

Commonly used, polyurethane is a softer, open cell foam. Best for lighter weight sensitive equipment such as cameras, smartphones and laptops. Available in a variety of densities.

ANTI-STATIC POLYURETHANE:

This special foam inhibits the build up of static electricity and helps dissipate any stray static charge. It is an open cell foam that is used for lightweight items such as sensitive electronic equipment, e.g. circuit boards, computer chips, etc.

POLYETHYLENE:

Polyethylene foam is a strong, non-abrasive, water-resistant and resilient closed cell foam. Due to its excellent vibration dampening and insulation properties, it is often used for packaging fragile goods such as communications equipment, power supplies, etc. Available in a variety of densities.

ANTI-STATIC POLYETHYLENE:

Commonly used for shipping electronic parts, circuit boards and computer chips, anti-static polyethylene foam is a strong, non-abrasive, water-resistant and resilient closed cell foam. The properties of the foam slowly dissipate electrostatic charges given off by other components. Used for shock absorption, it is often used for packaging fragile goods due to its excellent vibration dampening and insulation properties.

CROSS-LINK:

Is a non-porous, non-particulate closed cell foam that is often used in a clean room environment (reduces foreign object debris – FOD). It is aesthetically pleasing and resistant to grease, dirt and water. Available in a variety of densities.

ADDITIONAL FOAM TYPES ARE AVAILABLE: FLAME-RETARDANT, CONDUCTIVE, EXPANDED FOAMS...

CUSTOM FOAM APPLICATION EXAMPLES:

- Consumer Products
- Firearms
- Computers
- Calibrated Optics
- Tools
- Video Equipment
- Bottles
- Paintings
- Musical Instruments
- Collectibles
- Any Item That You Value and Need To Protect



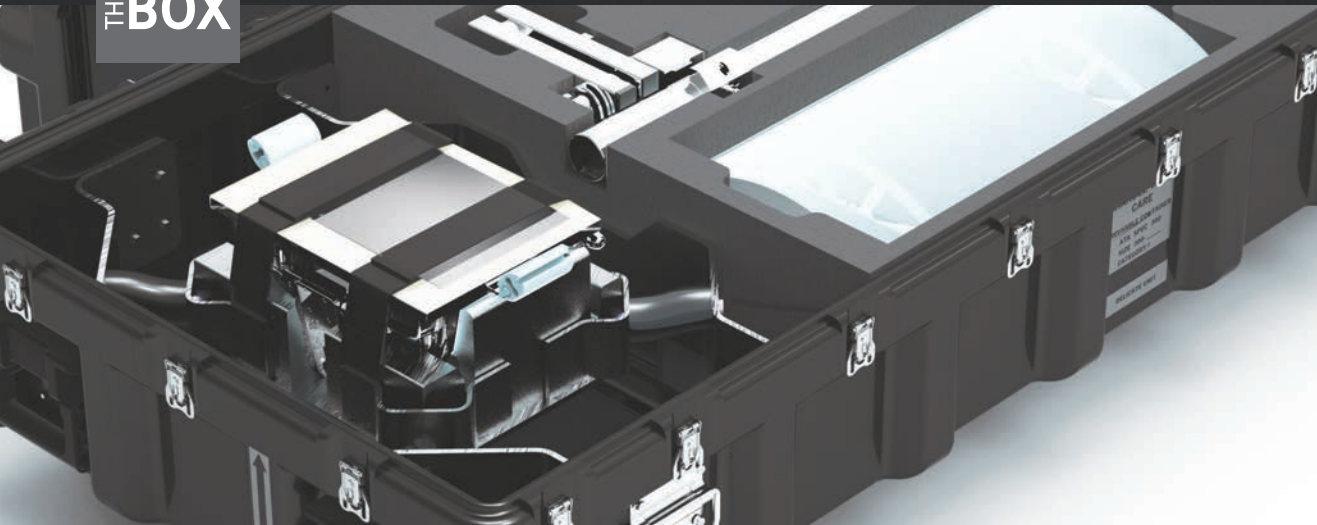

BEYOND FOAM

When foam is not appropriate, Pelican specializes in custom metal work to help keep your equipment secure and stable, to arrive without a scratch.

LAB TESTING

Military and OEM customers may need to certify the case will perform to specific requirements. Under precise control conditions we subject our cases to a battery of rigorous lab tests including drop, vibration, leak, heat and dust tests.



DECK MOUNT SUSPENSION SYSTEM

While foam is generally the first choice for protection, heavy or extremely fragile equipment sometimes requires fabrication of custom deck mount suspension systems to secure equipment. Cradle mounts are also the choice when the equipment can only be supported in precise locations. Pelican's machine shop is world-class, with plasma cutters, certified welders and finishing services demanded by the aerospace, defense and medical industries.

VIBRATION CONTROL

Small but constant vibration during transport is very destructive to the equipment inside a case. Pelican uses elastomer shock mounts, cable shock isolators, hard mounts, and foam that isolate the payload from case walls. Specialized foams can also mitigate vibration; our engineers understand the properties of foam to specify the type that is right for your requirements.



VIBRATION TEST

- L.A.B. servo hydraulic vibration system; 0 – 300 Hz.
- Sinusoidal with pre-programmed profiles for:
 - ISTA Integrity test procedures 11800, 14200, 1A, 1B, 1E, 1C, 1D, 2A AND 2B.
 - FED-STD-101C; 5019-1
 - 3 – 50 Hz sweep with 1G constant input
 - 1 inch dwell for loose cargo bounce
 - Mil-Std-648C; 5.3.2
- Random Vibration with pre-programmed profiles for:
 - ASTM D 4169 Air levels 1, 2, and 3
 - ASTM D 4169 Truck levels 1, 2, and 3
 - ASTM D 4169 Rail levels 1, 2, and 3
 - ISTA Integrity Test Procedures 1E, 1H, 1C, 1D, 1F, 3C, 3D, and 3E.

DROP TESTING

- Six foot cube reaction mass of reinforced concrete. A hoist capable of lifting 1 ton, and a quick release mechanism with a load capacity of ½ ton.

IMPACT TEST

- Falling dart – 84 inch drop height with darts weighing between 5 and 15 lbs.
- Penetration test for category 1 containers - ATA 300 paragraph B-2-5

THERMAL TEST

- Walk in environmental chamber 6-foot wide by 8 foot high and 8 feet deep with a thermal range of -100°F to 200°F.

IMMERSION TEST

- Internal dimension of the chamber is 54" x 30" x 36"H. Able to simulate immersions up to 2 meters.
- Small immersion tank capable of immersions up to 1 meter on small IM cases.
- 80 inch deep large immersion tank

RAIN TEST

- Small rain chamber capable of up to 4 inches per hour.

PNEUMATIC PRESSURE TESTING

- 100" and 80" water manometers
- 100" mercury manometer.
- Digital manometer – 10 psi max.

MITUTOYO™ HARDNESS TESTER

- Metal evaluation of product used in cases.

COMPRESSION AND TENSILE TESTING

- Instron compression tester, model 3367.
- Load range of 6600 lbs on small items.

LEAK TEST

- Immersion: 54" x 30" x 36" high chamber. Able to simulate immersions up to 2 meters.
- Rain: Small rain chamber capable of up to 4 in. per hour.
- Pneumatic Pressure: 100" and 80" water manometers. 100" mercury manometer.
- Digital manometer – 10 psi max.



GET 20% TOUGHER AND HUNDREDS OF ADDITIONAL SIZE OPTIONS: ROTATIONALLY MOLDED CASES

Our rotationally molded cases begin as resin powder, measured and loaded into a mold attached to a biaxial arm. As the mold rotates and heats up, 20% more resin accumulates in the corners and edges where it is needed most. This ensures that your case holds up against extreme drops and impacts.

Each case is made in the USA and many are tested to Mil-Spec standards. With over 400 case sizes available, you get more options that have passed rigorous testing to ensure your equipment moves through punishing environments unrattled.

See pelican.com for all case styles and sizes.

CHOICE

With hundreds of case sizes and options available, we have the widest range of standard configurations in the industry.



SINGLE LID CASES

Rugged protection with detachable lids for easy access.



RACK MOUNT CASES

Built-in shock absorbing frames protect electronic equipment.









ISP CASES (INTER-STACKING PATTERN)

Best protection for pallet shipments.

STANDARD ACCESSORIES

								
Casters	Edge Casters (standard on MAC with 5" lid)	Caster Storage in Lid	Metal or Comfort Grip Handles	Extra Handles	Card Holders	ID Plates	Front Labels	Standard Labels
								
Custom Stenciling	Airtight/Watertight Valves	Coupling Catches	Humidity Indicators	Lid Hangers	Lid Storage Pouches	Lift Rings/Tie Down Rings	Leg Kit Chair or Tables	Lockable Cable Catches (1 set of 4 ea)

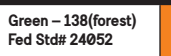
OPTIONAL COLORS FOR ALL SINGLE LID CASES

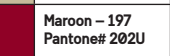
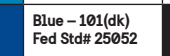
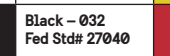
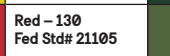
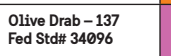
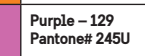
 Gray - 133 Fed Std# 26270	 Tan - 250 Fed Std# 20372	 Blue - 135(lt) Pantone# 292U	 White - 132 Fed Std# 27925	 Yellow - 136 Pantone# 012U	 Green - 138(forest) Fed Std# 24052	 Orange - 134 Fed Std# 12197
 Yellow - 131 Fed Std# 23538	 Maroon - 197 Pantone# 202U	 Blue - 101(dk) Fed Std# 25052	 Black - 032 Fed Std# 27040	 Red - 130 Fed Std# 21105	 Olive Drab - 137 Fed Std# 34096	 Purple - 129 Pantone# 245U

Note: Some options are not available on all case sizes and availability is subject to change at manufacturer's discretion. Case colors/options may differ slightly from printed versions.